



AMFE Catalogue

Automatic miniature fire extinguishing unit



Simply. More. Safety.

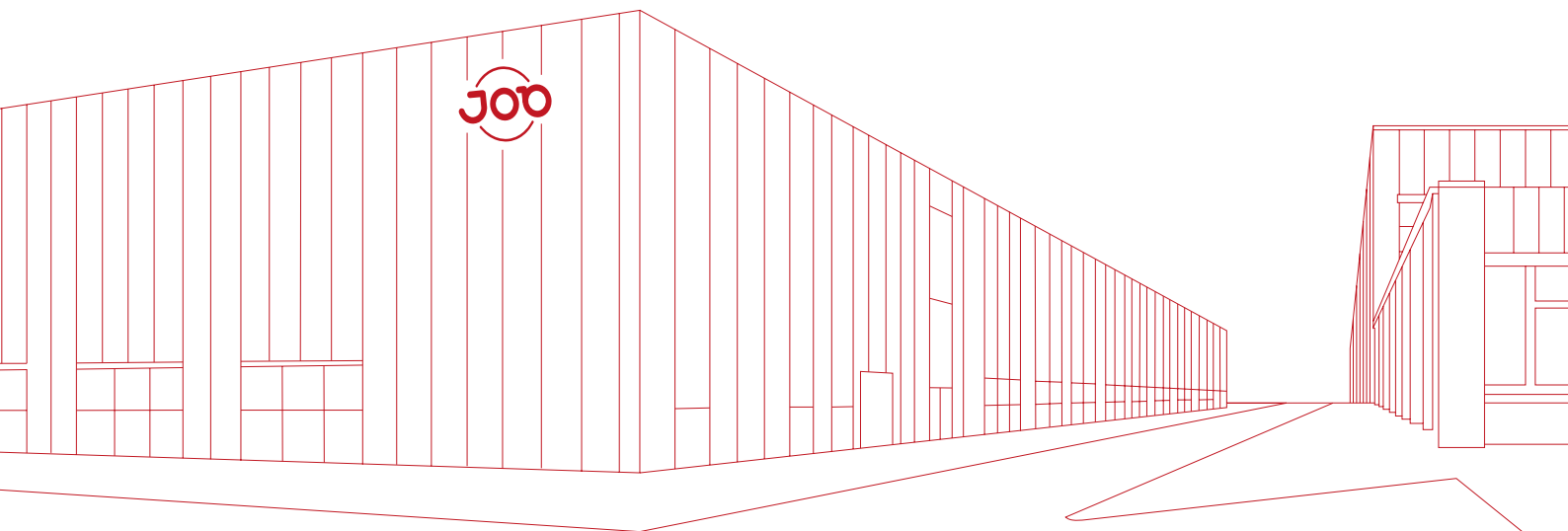

Table of contents

We are JOB	4
Introduction of device-integrated fire protection	5
The extinguishing agents	6
Areas of application	7
Automatic miniature fire extinguishing unit (AMFE)	
The system	8
Our portfolio	9
Product overview	10
References	14
Technical data	18
Installation of the AMFE	20
FAQs	21
Other innovative extinguishing systems	22



We are JOB

Our vision is a world in which everyone is protected from the dangers of fire at all times.



Philip & Bodo Müller, Managing Directors

Our home is just outside Hamburg - our products ensure safety all over the world

The JOB Group is a powerful association of individual companies in the field of technical fire protection. These individual companies concentrate research, development, production and sales of sustainable solutions "Made in Germany". As the world market leader for heat-sensitive glass bulbs for the sprinkler and automotive industry, the values and vision under the roof in Ahrensburg have been characterized by quality and safety for more than 50 years. JOB is committed to a world in which everyone is protected from the dangers of fire at all times.

To make this vision a reality, engineers and scientists from different nations and disciplines work hand in hand. The patented fire-extinguishing thermal fuse and the invention of the smallest automatic fire extinguisher in the world are also JOB products that protect people permanently from the dangers of fire.

Company awards:



Product awards:

(Extract)



Certification as a reliable economic operator in foreign trade:



Introduction of device-integrated fire protection

What is device-integrated fire protection?

Statistically, electricity causes a fire every 6 minutes in Germany. Many fires start in electrical appliances, including switch cabinets.

To prevent expensive damage or business interruptions in the event of a fire, it makes sense to detect the fire as early as possible and directly at its source and extinguish it while it is still small. This is precisely where device-integrated fire protection comes into play, at the source of the fire. The fire protection concepts used in the past are good, but they usually only extinguish the fire once the fire has spread beyond the electrical equipment. The damage is therefore greater than it needs to be.

With device-integrated fire protection can make safe electronics even safer.



30% of all fires are caused by electricity, many of them in electrical appliances.

Source: IFS Kiel



Business interruptions due to fires are the biggest risk for companies, along with cyber attacks.

Source: Allianz Risk Barometer



40% of all businesses are insolvent after suffering fire damage in the first year.

Source: Gesamtverband der Versicherer (GDV)



The protection of critical infrastructure is becoming increasingly important.

Source: Directive (EU) 2022/2557



Increase of quality and safety



Increase resilience and insurability!



Reduce product recall costs. Minimize the risk!



Get building approval more easily. More turnover!



Integrated fire stop as a unique selling point



Reduce product costs. Savings possible!

The extinguishing agents

The AMFE is a modular system and several extinguishing agents can be used. In addition to CO₂ (on request), FK-5-1-12 is selected as standard due to the advantages listed below.

The advantages at a glance:



non-toxic



residue-free



non-conductive



no ozone
depletion potential



non-corrosive &
no contamination



low investment



no aerosol dust or
hard-to-clean deposits

Applications of device-integrated fire protection

The solution for numerous applications

The automatic miniature fire extinguishing unit (AMFE) provides effective protection against fire hazards in industrial and domestic environments, in switch cabinets, in media technology and many other applications.



MEDIA TECHNOLOGY



DIGITAL SIGNAGE



SWITCH CABINETS



VENDING MACHINES



MUSEUM



MACHINES



Automatic miniature fire extinguishing unit (AMFE)

The system

The AMFE automatically detects a fire in switch cabinets and electrical appliances. The system prevents the spread of fire and further damage to property. The AMFE from JOB protects devices and systems in industry, households and consumer electronics (e.g. machines, media technology, snack machines, etc.).

Safe triggering thanks to proven billions of times Thermo Bulb technology



57°C 68°C 79°C 93°C 141°C

Selectable trigger temperature

Simple maintenance options

Once a year by checking the pressure range

Digital maintenance through continuous pressure measurement (4-20 mA signal/single switching point)



The cylinder grows with the protection volume (in m³)

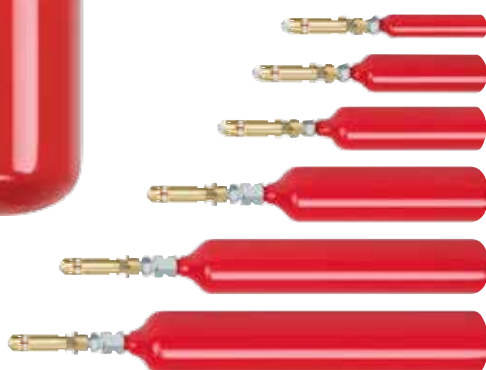

Size	Class A Fire VdS 2381 (5,8%)	Class A Fire EN 15004-2 (5,3%)
0	0,046	0,050
1	0,137	0,151
2	0,229	0,251
3	0,459	0,505
4	0,686	0,754
5	1,149	1,264

By using the Multialert® Mini, multiple AMFEs can be used, thereby increasing the extinguishing volume.

Our portfolio



The Multialert® Mini

AMFE



S-AMFE



R-AMFE



Remote activation

Signal when activated

Automatic release due to heat

Various release units

The AMFE system can be easily expanded and combined to form an ecosystem.

AMFE – Multialert® Mini

The Multialert® Mini control unit is the ideal extension for the AMFE system. Using the Multialert® Mini increases the protected volume. The integration of smoke switches and the connection of external detectors is possible.

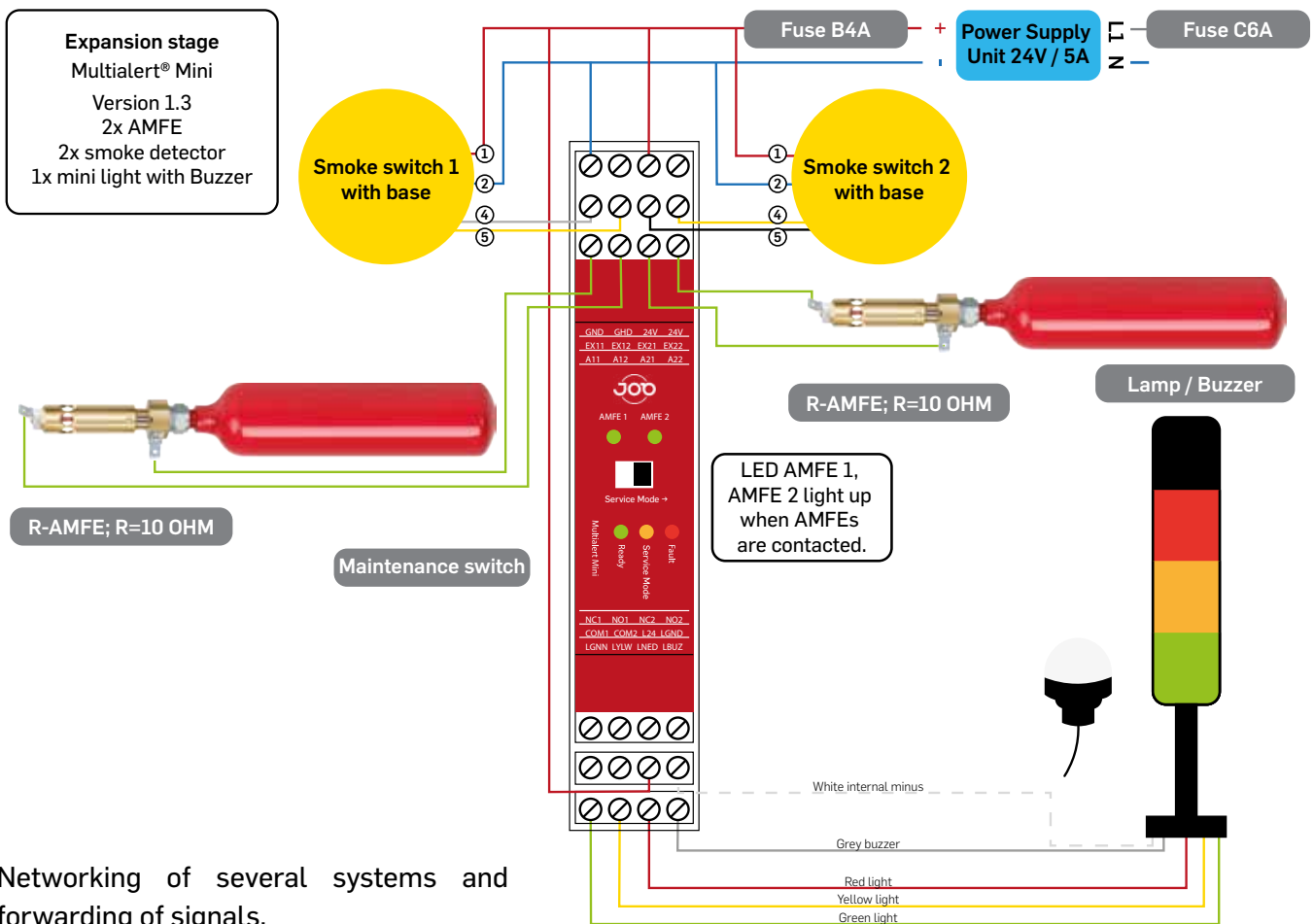

Networking of several systems and forwarding of signals.

PRODUCT OVERVIEW

AMFE | S-AMFE | R-AMFE – release units

AMFE	Article number	
57°C	100849	Thermal activation
68°C	100575	
79°C	100576	
93°C	100577	
141°C	100573	
182°C	100574	
<hr/>		
S-AMFE	Article number	
57°C	100847	Thermal triggering and signaling
68°C	100592	
79°C	100593	
93°C	100594	
<hr/>		
R-AMFE	Article number	
57°C	100845	Thermal or electrical triggering and signaling
68°C	100582	
79°C	100583	
93°C	100584	



Extinguishing agent cylinders for the AMFE series

Cylinder size	Article number	
Size 0	100708	A red cylindrical extinguishing agent cylinder with a silver-colored mounting bracket on the right end.
Size 1	100709	
Size 2	100710	
Size 3	100711	
Size 4	100712	
Size 5	100713	

Extinguishing agent cylinder for the AMFE series with pressure gauge

Cylinder size	Article number
Size 0	100772
Size 1	100773
Size 2	100774
Size 3	100775
Size 4	100776
Size 5	100778



Extinguishing agent cylinder for the AMFE series with electronic pressure switch

Cylinder size	Article number	Content of extinguishing agent in cylinder (ml)
Size 0	100926	22
Size 1	100927	72
Size 2	100928	120
Size 3	100929	241
Size 4	100930	360
Size 5	100931	603



Extinguishing agent cylinder for the AMFE series with 4-20mA pressure sensor (M12 connector)

Cylinder size	Article number
Size 0	100787
Size 1	100788
Size 2	100789
Size 3	100790
Size 4	100791
Size 5	100792



Product overview

Mounting options

Magnetic holder kits

Size of the bracket	Article number	for cylinder size	Number of magnetic holders per cylinder sized <small>incl. screw, nut and washer.</small>
Size 0	100958	Size 0	1
Size 1	100959	Size 1	1
Size 2	100960	Size 2	2
Size 3 & 4	100961	Size 3 & 4	2
Size 5	100962	Size 5	2



Roof mounting kit

Mounting set	Article number	for cylinder size	
Set for cylinder size 0	100870	Size 0	<p>The set is supplied with a mounting bracket and a matching bracket set (incl. screw, nut, washer) and seal.</p> 
Set for cylinder size 1	100871	Size 1	
Set for cylinder size 2	100894	Size 2	
Set for cylinder size 3 & 4	100893	Size 3 & 4	
Set for cylinder size 5	100892	Size 5	

Holder kits for screw mounting

Size of the bracket	Article number	for cylinder size	Includes the recommended number of brackets. <small>Includes screw, nut, and washer.</small>
Size 0	100865	Size 0	1
Size 1	100866	Size 1	1
Size 2	100867	Size 2	2
Size 3 & 4	100868	Size 3 & 4	2
Size 5	100869	Size 5	2



Accessories

Product name	Article number
Multialert® Mini Scalable for extinguishing volumes up to 6.8 m³	400005
Smoke switch ORS 142 Ö	400006
Smoke switch Base 143 A	400007
Werma MC55 RGY buzzer M12 connector 24VDC	400027
Sensor/actuator cable, 5-pin, black, angled M12 plug to free cable end, length: 2 m	400037
Sensor/actuator cable, 5-pin, black, angled M12 plug to free cable end, length: 5 m	400042



AMFE demo case

Demo case	article number
AMFE demo case JOB Logo	100599



References AMFE



Many well-known companies already rely on device-integrated fire protection to ensure the safety of their buildings and facilities. The AMFE is used in various areas, including shopping centers, industrial facilities, municipalities and local authorities.



AMFE protects information system in several ECE Centers. With the new Digital Center News Club (DCNC), ECE Marketplace GmbH & Co. KG has developed a new type of center information system. The special feature is that only center-specific and shopping-relevant content can be found here. Daily program items are optimally timed to generate an increased urge to act among visitors. Thanks to integrated fire protection and the AMFE, critical locations in particular can also be realized.

The FTI Group is a German travel group headquartered in Munich and the third largest tour operator in Europe. In order to guarantee the uninterrupted distribution of package and modular tours at all times, the electrical systems and controls at the headquarters must be fail-safe and reliable.

Preventive fire protection plays an important role here, and with 40 control cabinets at the Munich site alone, a fire protection solution had to be found that was networked, simultaneous and absolutely reliable. FTI Touristik GmbH opted for AMFE for this.

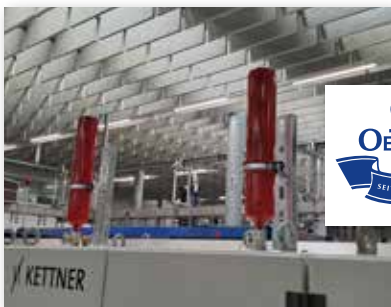

High safety standards apply in the food industry in particular, including with regard to fire protection. The Oettinger brewery in Braunschweig has equipped its machines with the AMFE to reduce the risk of fire.



In order to improve the networking of various transport companies at the Vorburgplatz mobility hub in the municipality of Trittau, a central point was to be provided for calling a cab, making an emergency call or obtaining timetable information from the Hamburger Verkehrsverbund. To ensure that the connected locations can be reached at all times, the municipality of Trittau also opted for integrated fire protection in its information service pillar in order to be informed as soon as possible in the event of a technical defect and to extinguish an incipient fire directly.

TK Elevator is one of the world's largest manufacturers of elevator systems. To ensure the safety of its products and to keep the failure rate as low as possible, TK Elevator also tests important components under various extreme climatic conditions in a climatic chamber during development. These are equipped with the AMFE.



Fire protection is of crucial importance – especially in sensitive areas such as escape and rescue routes, where the requirements are particularly high. In hospitals in particular, where the protection of patients and staff is a top priority, every possible risk must be minimized. Hospitals are therefore increasingly relying on innovative safety measures such as the installation of AMFE in snack vending machines in escape and rescue routes.

References E-Bulb



The E-Bulb, the smallest fire extinguisher in the world, is simply installed in the electronics and protects around the clock. The areas of application are numerous. They range from power adapters in advertising screens (media technology) to ventilators in medical technology and household appliances in the home.



Berlin Brandenburg Airport relies on device-integrated fire protection. With around 23.1 million passengers and 176,649 aircraft movements in 2023, it is the third largest airport in Germany. Due to the high daily number of passengers, it represents both a critical infrastructure and a sensitive area. At the same time, it offers advertisers an attractive platform for targeting travelers. Four new LED walls were installed above the marketplace - the shopping area of the airport behind the security checkpoints. Thanks to the integrated "Made by JOB" fire protection system, they comply with the latest safety and fire protection regulations.

The security requirements for technical infrastructure at Frankfurt am Main Airport are high. In order to obtain approval for the installation of media technology in this sensitive area, a large SAMSUNG LED wall in Terminal 1 (A) was equipped with E-Bulbs, among other things. The fire protection experts came to the conclusion that the media wall was thus transformed from a "fire initiator" into a mere "fire participant".





Hamburg Airport is one of the largest airports in Germany. Integrated fire protection was a key decision criterion when purchasing and installing the new "Plaza Window" LED wall directly at the security gate. An elementary component of the sophisticated fire protection concept developed in advance was the use of e-bulbs. These make it possible to fight any fire inside the media wall at an early stage - thus ensuring maximum safety.

The digital houseboard developed by gekartel AG is a modern medium that enables real-time interaction and communication in apartment buildings. A modern touchscreen replaces the outdated bulletin boards and the associated paperwork. However, the fire protection regulations in listed buildings were often an obstacle to the installation of the digital house panel, as the wood-paneled hallways are considered escape and rescue routes in which even the smallest electrical fires can degenerate into large wildfires. Thanks to the integrated fire protection, however, this danger has been averted and the house panel can now also be installed in sensitive areas.



Technical data

Measurements and weights

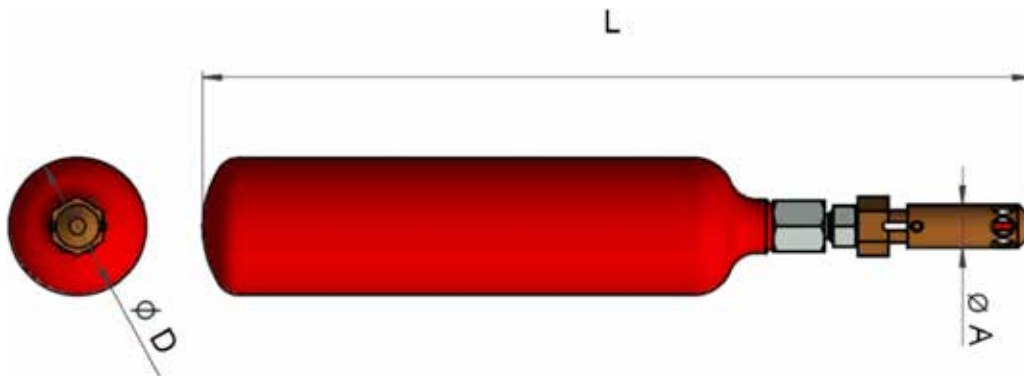

Standard cartridge

AMFE head with extinguishing agent cartridge	Measurements (mm)			Weight	
	L	D	A	kg	Lbs
0	194,5	22,0	16	0,25	0,55
1	210,0	35,0	16	0,44	0,97
2	240,5	40,0	16	0,63	1,39
3	307,0	50,8	16	1,23	2,71
4	392,0	50,8	16	1,70	3,75
5	438,0	60,3	16	2,70	5,96



Cylinders with pressure gauge and electronic sensor

AMFE head with Extinguishing agent cartridge with pressure gauge	Measurements (mm)			Weights
	L	B	H	kg
Size 0	264,5	22,0	16	0,45
Size 1	280,0	35,0	16	0,64
Size 2	310,5	40,0	16	0,83
Size 3	377,0	50,8	16	1,43
Size 4	462,0	50,8	16	1,90
Size 5	508,0	60,3	16	2,90

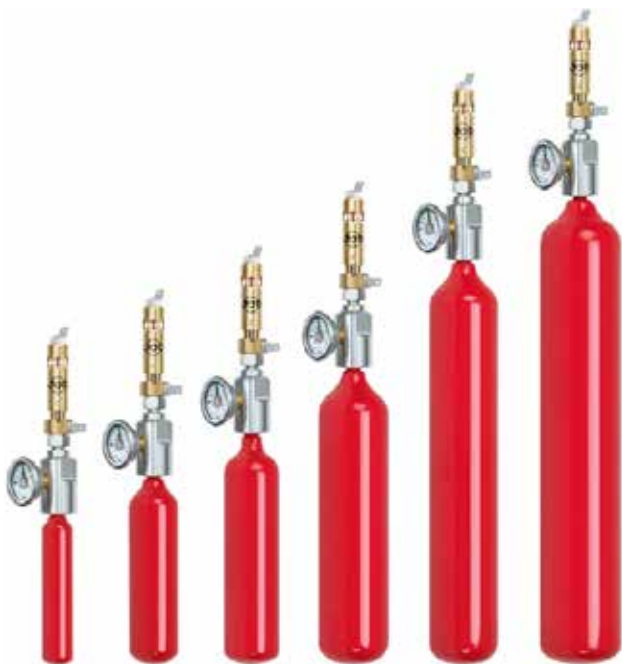

Size comparison of the 6 sizes
(cylinder with pressure gauge)

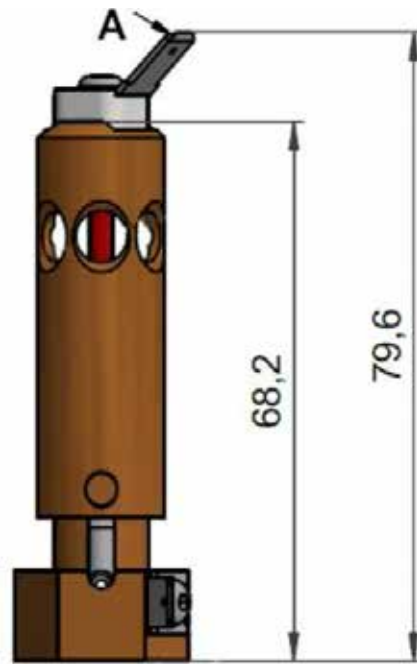

Dimensions R-AMFE release head
A → 6.8 mm industrial flat plug

The weight of the R-AMFE trigger head is 78 g.

The connection thread of the ignition head to the cylinder is M11 (M19 wrench).

Extinguishing agent

The cylinder is filled an innovative fire extinguishing agent and compressed nitrogen (N₂) as propellant.

The quantity of the extinguishing agent per cylinder size is listed in the table below:

- Size 0 24ml
- Size 1 72ml
- Size 2 120ml
- Size 3 241ml
- Size 4 360ml
- Size 5 603ml

The ~ 10% propellant gas N₂ is compressed (<60bar).

The manufacturer's design rules apply (see product manual).

Installation of the AMFE

Please observe the following instructions when installing the AMFE.

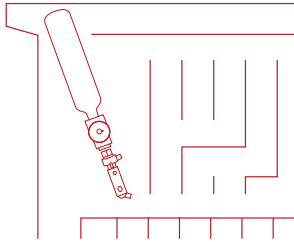

Position as high up as possible

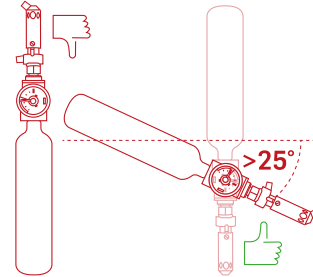

Attach AMFE at an angle of $>25^\circ$

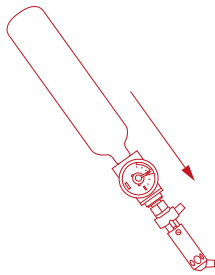

Align AMFE head downwards

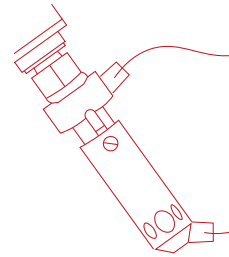

Networking the AMFE to other systems

Application of the AMFE

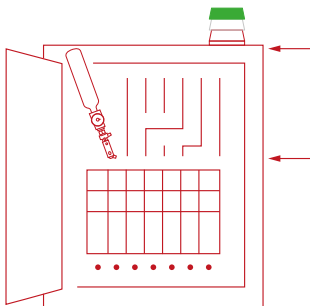

Installation of the AMFE in the switch cabinet

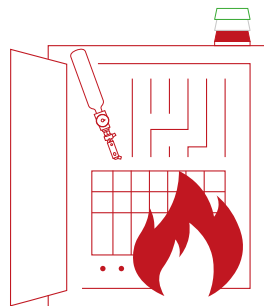

The fire breaks out

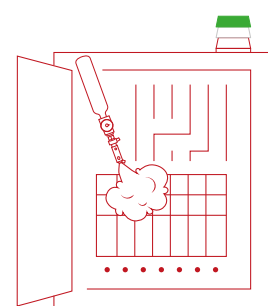

The AMFE extinguishes the fire quickly and without leaving any residue and reports the fire (R-AMFE)

FAQs

What are the most common causes and sources of fire?

One in three fires is caused by electricity, many in electrical appliances. Quality-conscious manufacturers have been bringing safe products onto the market for years. The causes that can lead to a technical defect and possibly a fire are numerous and can never be ruled out 100%, even by manufacturers.

Common causes of fire are:

- Power supplies
- Voltage fluctuations in the grid
- Component error
- Operation outside the specification
- Aging
- Ambient conditions
- Cold solder joints
- Production errors
- and many more!

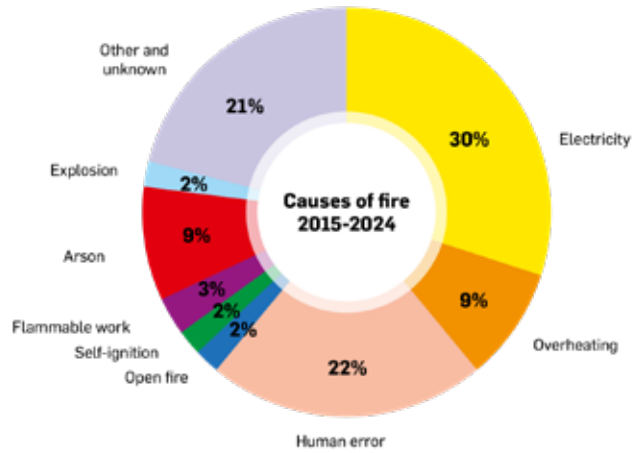

Source: IFS Brandursachenstatistik 2015-2024

What is device-integrated fire protection?

Statistically, there is a fire every 6 minutes in Germany due to electricity (statista.de). Many fires start in electrical appliances, including media technology. To avoid expensive damage or business interruptions in the event of a fire, it makes sense to detect the fire as early as possible and directly at its source and extinguish it while it is still small. This is exactly where device-integrated fire protection comes into play, at the source of the fire.

Where is the AMFE used?

The AMFE is a small extinguishing system for electrical switch cabinets and systems. The system is VdS-certified and is recommended by insurance companies. The AMFE automatically detects a fire in switch cabinets and electrical appliances. The system prevents the fire from spreading and further damage to property.

How many AMFEs do I need for use in the control cabinet?

The number of AMFEs in the control cabinet depends on the height, width and depth of the control cabinet. The AMFE configurator can be used to determine the right choice of AMFE.

Other innovative extinguishing systems

The smallest fire extinguisher in the world – E-Bulb

The E-Bulb is a fire-extinguishing thermal fuse and consists of a coated glass ampoule filled with residue-free extinguishing agent. The smallest version is just two centimeters in size, as small as a typical fine-wire fuse or a 1 euro coin. This makes the E-Bulb the smallest fire extinguisher in the world.



If a fire starts inside the electrical appliance, the E-Bulb detects the fire and extinguishes it automatically. In addition, the power is permanently interrupted to prevent re-ignition. This prevents high consequential fire damage and reduces the risk of business interruptions. Based on the sprinkler glass technology that has proven itself a billion times over, the E-Bulb was developed in Germany. 100% Made in Germany.

-
- ✓ Improved safety
 - ✓ Small design
 - ✓ Simple installation
 - ✓ Cost-effective
 - ✓ Maintenance-free
 - ✓ No consequential damage
 - ✓ 100% Made in Germany

More information: www.e-bulb.com

Your contact persons



Markus Fiebig

Sales Manager Extinguishing Products, Product Manager AMFE & E-Bulb

E-Mail: Markus.Fiebig@job-group.com

Phone: +49 (0) 4102 2114 223

Nico Kühn

Business Development & Sales Extinguishing products AMFE & E-Bulb

E-Mail: Nico.Kuehn@job-group.com

Phone: +49 (0) 4102 2114 530





JOB GmbH

Kurt-Fischer-Straße 30 • 22926 Ahrensburg • Germany
info@job-group.com • www.job-group.com